

DATE STAMPS

CH SERIES: COMPACT HEIGHT

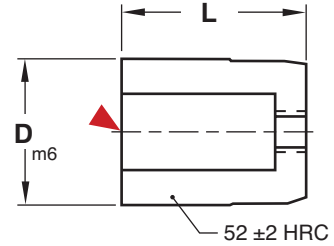

PLUGS

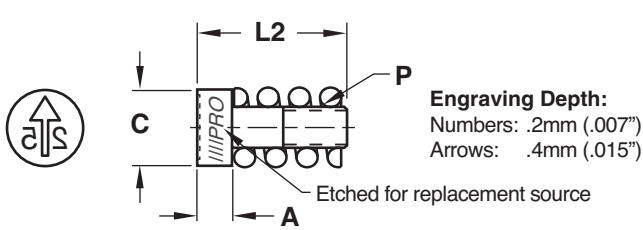

M 420 Stainless (1.4034) **H** 54-58 HRC

CATALOG NUMBER	C	A	L2	P
DCP04-25	2.2	2.0	8	M1x0.25
DCP05-25	3.1	2.0	8	M1.6x0.20
DCP06-25	3.1	2.0	8	M1.6x0.20
DCP08-25	4.4	2.5	10	M2.3x0.25
DCP10-25	5.2	3.0	12	M2.5x0.35
DCP12-25	6.2	3.0	14	M3x0.35
DCP16-25	8.2	3.5	14	M4x0.35
DCP20-25	11.0	4.5	16	M4x0.35

RINGS



▶ CAD insertion point

CATALOG NUMBER	D	L	B FROM GRAPHIC BELOW
DC04	4	8	1.4
DC05	5	8	2
DC06	6	8	2
DC08	8	10	3
DC10	10	12	3
DC12	12	14	4
DC16	16	14	5
DC20	20	16	5

To Order:

- Specify catalog number as shown above and below for the different style plugs and rings.
- Where years are specified (*), any year can be ordered by changing the suffix. Example: DCP05-26 or DCY05-27.
- Use both the Weeks Ring (DCW) and 0-9 Ring (DCN) to designate specific weeks of the year.
- Plugs include springs and replacements are available.
- Special configurations are available. Contact Customer Service for more information.

APPLICATION GUIDELINES

- Maximum mold temperature: 285°F (140°C)

Plug Styles: Recessed Lettering

Arrow Only

 Cat #: DCP-Diam-AO
Ex.: DCP05-AO

C

 Cat #: DCP-Diam-C
Ex.: DCP05-C

Ring Styles: Recessed Lettering

0 - 9

 Cat #: DCN-Diam
Ex.: DCN05

A - M

 Cat #: DCA-Diam
Ex.: DCA05

Blank

 Cat #: DC-Diam-B
Ex.: DC05-B

N - Z

 Cat #: DCZ-Diam
Ex.: DCZ05

Days

 Cat #: DCL-Diam
Ex.: DCL05

Years

 Cat #: DCY-Diam-Starting Year*
Ex.: DCY05-25

Note: The DCL04 and DCL05 does not have tick marks.

Quarters

 Cat #: DCQ-Diam
Ex.: DCQ05

Shifts

 Cat #: DCS-Diam
Ex.: DCS05

Weeks

 Cat #: DCW-Diam
Ex.: DCW05

